

INSPIRON™

SETUP GUIDE





INSPIRON™

SETUP GUIDE

Model PP19S

Notes, Cautions, and Warnings

 **NOTE:** A NOTE indicates important information that helps you make better use of your computer.

 **CAUTION:** A CAUTION indicates either potential damage to hardware or loss of data and tells you how to avoid the problem.

 **WARNING:** A WARNING indicates a potential for property damage, personal injury, or death.

Information in this document is subject to change without notice.

© 2009 Dell Inc. All rights reserved.

Reproduction of these materials in any manner whatsoever without the written permission of Dell Inc. is strictly forbidden.

Trademarks used in this text: *Dell*, the *DELL* logo, *Inspiron*, and *YOURS IS HERE* are trademarks of Dell Inc.; *Intel* is a registered trademark and *Atom* is a trademark of Intel Corporation in the U.S. and other countries; *Microsoft* and *Windows* are either trademarks or registered trademarks of Microsoft Corporation in the United States and/or other countries; *Ubuntu* is a registered trademark of Canonical Ltd.; *Bluetooth* is a registered trademark owned by Bluetooth SIG, Inc. and is used by Dell under license.

Other trademarks and trade names may be used in this document to refer to either the entities claiming the marks and names or their products. Dell Inc. disclaims any proprietary interest in trademarks and trade names other than its own.

February 2009

P/N K621P

Rev. A00

Contents

Setting Up Your Inspiron™ Mini 10	5	Display Features	22
Before Setting Up Your Computer	5	Removing and Replacing the Battery	24
Connect the AC Adapter	6	Software Features	26
Connect the Network Cable (Optional)	7	Solving Problems	28
Press the Power Button	8	Network Problems	28
Microsoft® Windows® XP Setup	9	Power Problems	30
Ubuntu® Setup	9	Memory Problems	31
Enable or Disable Wireless	9	Lockups and Software Problems	32
Connect to the Internet (Optional)	10	Using Support Tools	34
Using Your Inspiron™ Mini 10	14	Dell Support Center	34
Right Side Features	14	System Messages	35
Left Side Features	16	Hardware Troubleshooter	36
Computer Base and Keyboard Features	18	Dell Diagnostics	37
Touch Pad Gestures	20		

Contents

Restoring Your Operating System	40
System Restore	40
Using Dell™ PC Restore	42
Operating System Reinstallation	44
Getting Help	46
Technical Support and Customer Service	47
Online Services	47
Automated Order-Status Service	48
Product Information	48
Returning Items for Repair Under Warranty or for Credit	49
Before You Call	50
Contacting Dell	51
Finding More Information and Resources	52
Specifications	54
Index	62

Setting Up Your Inspiron™ Mini 10

This section provides information about setting up your Inspiron Mini 10 and connecting peripherals.

Before Setting Up Your Computer

When positioning your computer, ensure that you allow easy access to a power source, adequate ventilation, and a level surface to place your computer.

Restricting airflow around your Inspiron Mini 10 may cause it to overheat. To prevent overheating ensure that you leave at least 10.2 cm (4 inches) at the back of the computer and a minimum of 5.1 cm (2 inches) on all other sides. You should never place your computer in an enclosed space, such as a cabinet or drawer when it is powered on.

 **WARNING:** Do not block, push objects into, or allow dust to accumulate in the air vents. Do not place your Dell™ computer in a low-airflow environment, such as a closed briefcase, while it is powered on. Restricting the airflow can damage the computer or cause a fire. The computer turns on the fan when the computer gets hot. Fan noise is normal and does not indicate a problem with the fan or the computer.

 **CAUTION:** Placing or stacking heavy or sharp objects on the computer may result in permanent damage to the computer.

Connect the AC Adapter

Connect the AC adapter to the computer and then plug it into a wall outlet or surge protector.

⚠ WARNING: The AC adapter works with electrical outlets worldwide. However, power connectors and power strips vary among countries. Using an incompatible cable or improperly connecting the cable to a power strip or electrical outlet may cause fire or permanent damage to your computer.

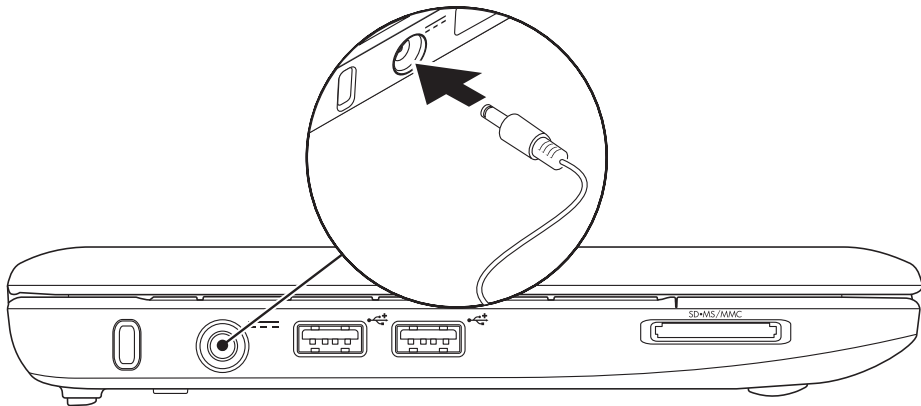

Connect the Network Cable (Optional)

To use a wired network connection, connect the network cable.

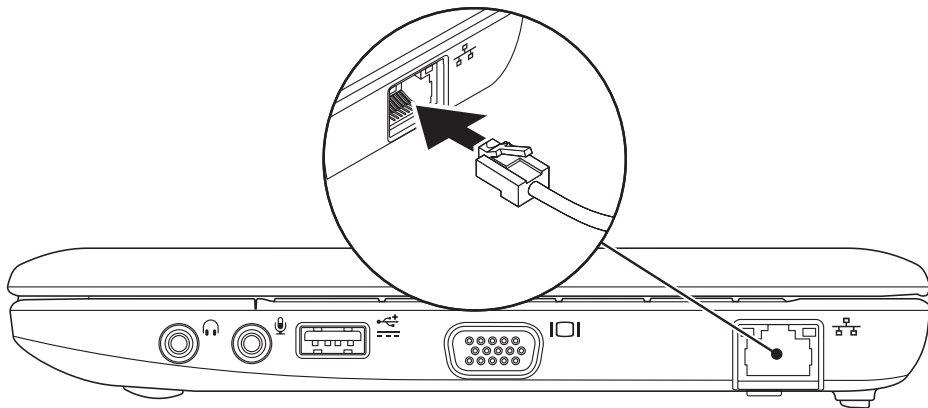

Press the Power Button

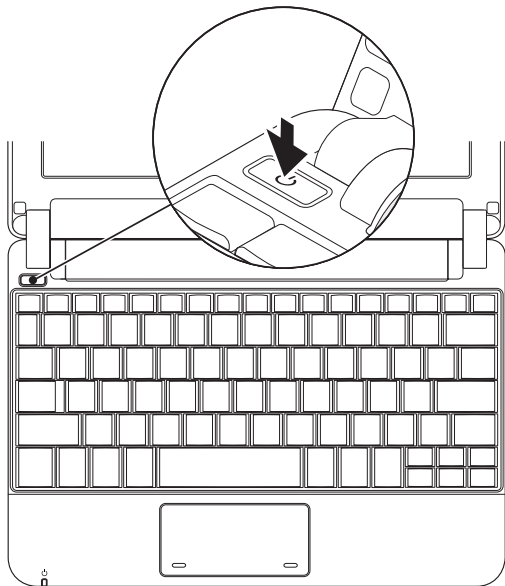

Microsoft® Windows® XP Setup

If you ordered Windows XP operating system with your computer, it is already configured. To set up Windows XP for the first time, follow the instructions on the screen. These steps are mandatory and may take up to 15 minutes to complete. The screens will take you through several procedures including accepting license agreements, setting preferences and setting up an Internet connection.

 **CAUTION: Do not interrupt the operating system's setup process. Doing so may render your computer unusable.**

Ubuntu® Setup

If you ordered Ubuntu operating system with your computer, it is already configured. See the *Ubuntu Quick Start Guide* that shipped with your computer for more operating system specific information.

Enable or Disable Wireless

To turn on wireless, with the computer turned on:

1. Press <Fn><F2> or press the  key on the keyboard.

The **Wireless Enable/Disable** dialog box appears.

2. Select one of the following:
 - **Enable Bluetooth**
 - **Enable Wireless LAN**
3. Click **OK**.

To turn off wireless, press <Fn><F2> again to turn off all radios.

Connect to the Internet (Optional)

 **NOTE:** ISPs and ISP offerings vary by country.

To connect to the Internet, you need an external modem or network connection and an Internet service provider (ISP).

 **NOTE:** If an external USB modem or WLAN adapter is not a part of your original order, you can purchase one from the Dell website at www.dell.com.

Setting Up a Wired Connection

- If you are using a dial-up connection, connect the telephone line to the external USB modem (optional) and to the telephone wall jack before you set up your Internet connection.
- If you are using a DSL or cable/satellite modem connection, contact your ISP or cellular telephone service for setup instructions.

To complete setting up your wired Internet connection, follow the instructions in “Setting Up Your Internet Connection” on page 11.

Setting Up a Wireless Connection

 **NOTE:** To set up your wireless router, see the documentation that shipped with your router.

Before you can use your wireless Internet connection, you need to connect to your wireless router. To set up your connection to a wireless router:

 **NOTE:** The following steps were written for the Windows default view, so they may not apply if you set your Dell™ computer to the Windows Classic view.

1. Save and close any open files, and exit any open programs.
2. Click **Start**→ **Control Panel**.
3. Under **Network and Internet Connections**, select **Wireless Network Setup Wizard**.
4. Follow the instructions on the screen to complete the setup.

Setting Up Your Internet Connection

To set up an Internet connection, perform the steps in the following section.

1. Save and close any open files, and exit any open programs.
2. Double-click the ISP icon on the Microsoft Windows desktop.
3. Follow the instructions on the screen to complete the setup.

If you do not have an ISP icon on your desktop or if you want to set up an Internet connection with a different ISP, perform the steps in the following section.

 **NOTE:** If you cannot connect to the Internet but have successfully connected in the past, the ISP might have a service outage. Contact your ISP to check the service status, or try connecting again later.

Have your ISP information ready. If you do not have an ISP, the **Connect to the Internet** wizard can help you get one.

Setting Up Your Inspiron™ Mini 10

 **NOTE:** The following steps were written for the Windows default view, so they may not apply if you set your Dell™ computer to the Windows Classic view.

1. Save and close any open files, and exit any open programs.
2. Click **Start**→ **Control Panel**.
3. Under **Network and Internet Connections**, select **Setup or Change Your Internet Connection**.
4. Click **Setup**.
The **New Connection Wizard** appears.
5. Click **Connect to the Internet**.
6. In the next window, click the appropriate option:
 - If you do not have an ISP, click **Choose from a list of Internet service providers (ISPs)**.

– If you have already obtained setup information from your ISP but you did not receive a setup CD, click **Set up my connection manually**.

– If you have a setup CD, click **Use the CD I got from an ISP**.

 **NOTE:** Your computer does not have an internal optical drive. Use an external optical drive or any external storage device for the procedures that involve discs.

7. Click **Next**.

If you selected Set up my connection manually in step 6, continue to step 8. Otherwise, follow the instructions on the screen to complete the setup.

 **NOTE:** If you do not know which type of connection to select, contact your ISP.





8. Click the appropriate option under **How do you want to connect to the Internet?**, and click **Next**.
9. Use the setup information provided by your ISP to complete the setup.

Using Your Inspiron™ Mini 10

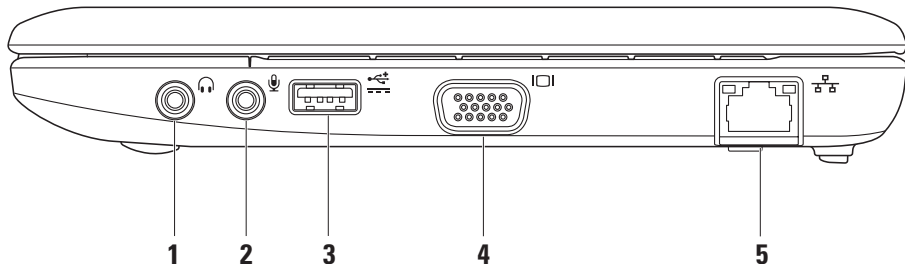
Your Inspiron Mini 10 has indicators and buttons that provide information and enable you to perform common tasks. The connectors on your computer provide the option of attaching additional devices.

Right Side Features



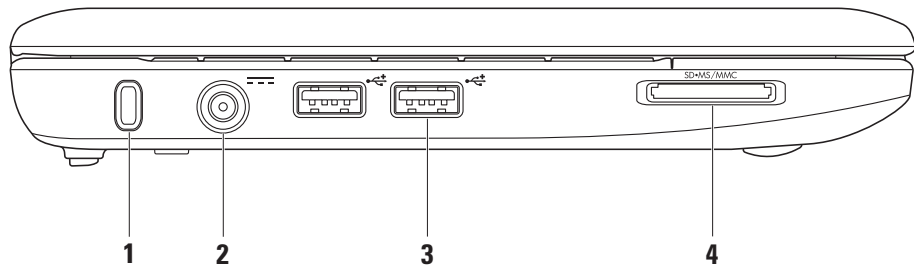

-  **1 Audio out/Headphone connector** – Connects to a pair of headphones, or sends audio to a powered speaker or sound system.
-  **2 Audio in/Microphone connector** – Connects to a microphone or input signal for use with audio programs.
-  **3 Power USB connector** – This connector can be used for USB devices that require more power. This connector supports up to 2 A current loading.
-  **4 VGA connector** – Connects to a monitor or projector.
-  **5 Network connector** – Connects your computer to a network or a broadband device if you are using a wired network.

Left Side Features



- 1 Security cable slot** – Attaches a commercially available antitheft device to the computer.

 **NOTE:** Before you buy an antitheft device, ensure that it works with the security cable slot on your computer.

-  **AC adapter connector** – Connects to the AC adapter to power the computer and charge the battery.

-  **USB 2.0 connectors (2)** – Connects to USB devices, such as a mouse, keyboard, printer, external drive, or MP3 player.

4



3-in-1 Media Card Reader – Provides a fast and convenient way to view and share digital photos, music, videos, and documents stored on the following digital memory cards:

- Secure Digital (SD) memory card
- Secure Digital High Capacity (SDHC) card
- Multimedia Card (MMC)
- Memory Stick
- Memory Stick PRO

Computer Base and Keyboard Features

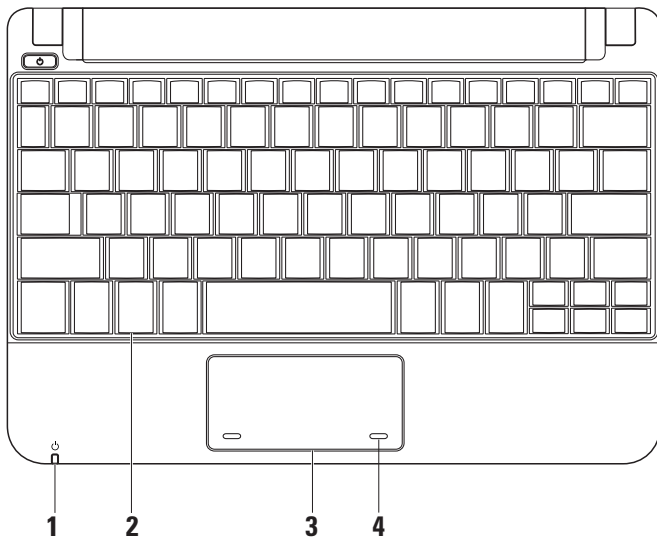

- 1**  **Power/Battery indicator light** – Turns on steadily or blinks to indicate power/battery charge status. The light indicates the following states while charging or using the computer with:
an AC adapter
- Solid white – The computer is on and/or the battery is charging.
 - Blinking white – The computer is in standby mode.
 - Off – The computer is off or in hibernate mode.
- a battery*
- Solid white – The computer is on.
 - Blinking white – The computer is in standby mode.
 - Blinking amber – The battery charge is low. Connect the AC adapter to charge the battery.
 - Off – The computer is off or in hibernate mode.

- 2 Keyboard** – Settings for this keyboard can be personalized by using the system setting utility.
- 3 Touch pad** – Provides the functionality of a mouse.
- 4 Touch pad buttons (2)** – Provides left- and right-click functions like those on a mouse.

Touch Pad Gestures

Scroll

Allows you to scroll through content. The scroll feature includes:

Traditional Scroll – Allows you to scroll up and down, or right and left.

To scroll up and down:

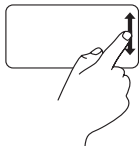

Move a finger up or down in the vertical scroll zone (extreme right of the touch pad) to scroll up or down on the active window.

To scroll right and left:

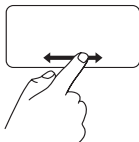

Move a finger right or left in the horizontal scroll zone (extreme bottom of the touch pad) to scroll right or left on the active window.

Circular Scroll – Allows you to scroll up and down, or right and left.

To scroll up and down:

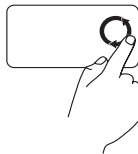

Move a finger in the vertical scroll zone (extreme right of the touch pad), in a clockwise circular motion to scroll up or counterclockwise circular motion to scroll down.

To scroll right and left:



Move a finger in the horizontal scroll zone (extreme bottom of the touch pad), in a clockwise circular motion to scroll right or counterclockwise circular motion to scroll left.

Display Features

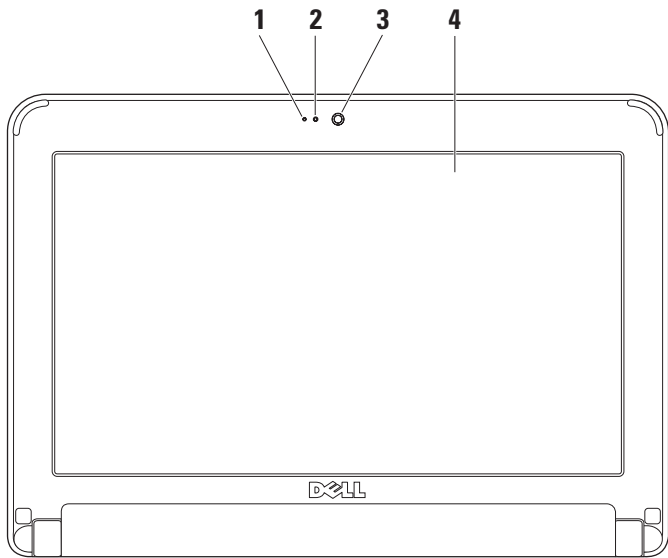

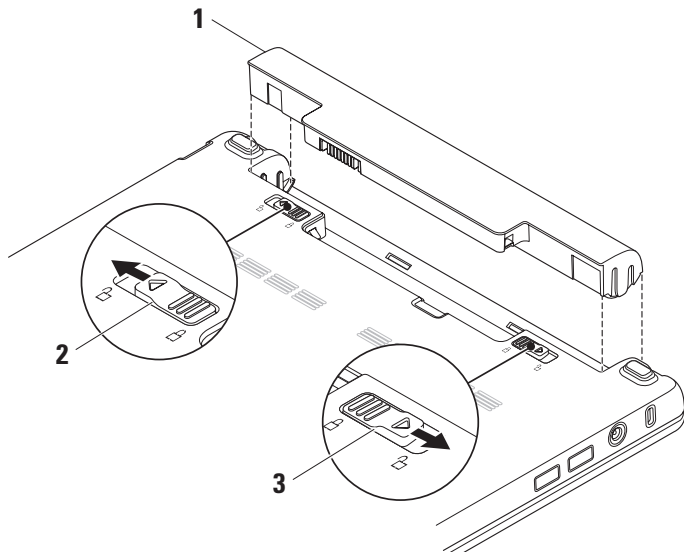

- 1 Microphone** – Provides quality sound for audio chatting and voice recording.
- 2 Camera activity light** – Indicates if the camera is on or off.
- 3 Camera** – Built-in camera for video capture, conferencing, and chat.
- 4 Display** – Your display can vary based on selections you made when purchasing your computer. For more information about displays, see the *Dell Technology Guide*.

Removing and Replacing the Battery



- 1 **Battery**
- 2 **Battery release latch**
- 3 **Battery lock latch**

 **WARNING: Using an incompatible battery may increase the risk of fire or explosion. This computer should only use a battery purchased from Dell. Do not use batteries from other computers.**

 **WARNING: Before removing the battery, shut down the computer, and remove external cables (including the AC adapter).**

To remove the battery:

1. Shut down the computer and turn it over.
2. Slide the battery lock latch until it clicks into place.
3. Slide the battery release latch to unlock position.
4. Pull the battery up and out of the battery bay.

To replace the battery, slide it into the bay until it clicks into place. Then slide the battery lock latch to the lock position.

Software Features

 **NOTE:** For more information about the features described in this section, see the *Dell Technology Guide* on your hard drive or on the Dell Support website at support.dell.com.

Productivity and Communication

You can use your computer to create presentations, brochures, greeting cards, fliers, and spreadsheets depending on the applications installed in your computer. Check your purchase order for software installed on your computer.

After connecting to the Internet, you can access websites, setup an e-mail account, upload and download files, and so on.

Entertainment and Multimedia

You can use your computer to watch videos, play games, listen to music and Internet radio stations.

Customizing the Desktop

You can customize your desktop to change the appearance, resolution, wallpaper, screensaver, and so on by accessing the **Display Properties** window.

To access the display properties window:

1. Right-click an open area of the desktop.
2. Click **Properties**, to open the **Display Properties** window and learn more about your customization options.

Backing Up Your Data

It is recommended that you periodically back up files and folders on your computer. To back up files:

1. Click **Start**→ **All Programs**→ **Accessories**→ **System Tools**→ **Backup**.
2. Follow the instructions in the **Back up Files** wizard.

Solving Problems

 **WARNING:** Only trained service personnel should remove the computer cover. See the *Service Manual* on the Dell Support website at support.dell.com for advanced service and troubleshooting instructions.

Network Problems

Wireless Connections

If the wireless network connection is lost —

The wireless router is offline or wireless has been disabled on the computer.

- Check your wireless router to ensure it is powered on and connected to your data source (cable modem or network hub).
- Interference may be blocking or interrupting your wireless connection. Try moving the computer closer to your wireless router.

- Re-establish your connection to the wireless router:
 - a. Save and close any open files, and exit any open programs.
 - b. Click **Start**→ **Internet Explorer**→ **Connect to the Internet**.
 - c. Follow the instructions on the screen to complete the setup.

Wired Connections

If the network connection is lost — The cable is loose or damaged.

- Check the cable to ensure it is plugged in and not damaged.

The link integrity light on the integrated network connector lets you verify that your connection is working and provides information on the status:

- Green — A good connection exists between a 10-Mbps network and the computer.
- Orange — A good connection exists between a 100-Mbps network and the computer.
- Off — The computer is not detecting a physical connection to the network.

 **NOTE:** The link integrity light on the network connector is only for the wired network cable connection. The link integrity light does not provide status for wireless connections.

Power Problems

If the power light is off — The computer is either turned off or is not receiving power.

- If the computer is plugged into a power strip, ensure that the power strip is plugged into an electrical outlet and that the power strip is turned on. Also bypass power protection devices, power strips, and power extension cables to verify that the computer turns on properly.
- Ensure that the electrical outlet is working by testing it with another device, such as a lamp.
- Check the AC adapter cable connections. If the AC adapter has a light, ensure that the light on the AC adapter is on.

If the power light is solid white and the computer is not responding — The display may not be responding. Press the power button until the computer turns off and then turn it back on.

If the power light is blinking white — The computer is in standby mode. Press a key on the keyboard, move the pointer using the touch pad or a connected mouse, or press the power button to resume normal operation.

If the power light is blinking amber — A device might be malfunctioning or the battery charge is low.

- If the computer is receiving electrical power, then a device might be malfunctioning or incorrectly installed.
- If the battery charge is low, connect the computer to the AC adapter.

If you encounter interference that hinders reception on your computer — An unwanted signal is creating interference by interrupting or blocking other signals. Some possible causes of interference are:

- Power, keyboard, and mouse extension cables.
- Too many devices connected to a power strip.
- Multiple power strips connected to the same electrical outlet.

Memory Problems

If you receive an insufficient memory message —

- Save and close any open files and exit any open programs you are not using to see if that resolves the problem.
- See the software documentation for minimum memory requirements.

If you experience other memory problems —

- Ensure that you are following the memory installation guidelines (see the *Service Manual* on the Dell Support website at support.dell.com).
- Run the Dell Diagnostics (see “Dell Diagnostics” on page 37).

Lockups and Software Problems

If the computer does not start up — Ensure that the power cable is firmly connected to the computer and to the electrical outlet.

If a program stops responding — End the program:

1. Press <Ctrl><Shift><Esc> simultaneously.
2. Click **Applications**.
3. Click the program that is no longer responding
4. Click **End Task**.

If a program crashes repeatedly — Check the software documentation. If necessary, uninstall and then reinstall the program.

 **NOTE:** Software usually includes installation instructions in its documentation or on the disc (CD or DVD).

 **NOTE:** Your computer does not have an internal optical drive. Use an external optical drive or any external storage device for the procedures that involve discs.

If the computer stops responding or a solid blue screen appears —

 **CAUTION:** You might lose data if you are unable to perform an operating system shutdown.

If you are unable to get a response by pressing a key on your keyboard or moving your mouse, press the power button for at least 8 to 10 seconds until the computer turns off and then restart your computer.

If a program is designed for an earlier Microsoft® Windows® operating system —

Run the Program Compatibility Wizard. The Program Compatibility Wizard configures a program so that it runs in an environment similar to non-XP operating system environments.

1. Click **Start** → **All Programs** → **Accessories** → **Program Compatibility Wizard**.
2. In the welcome screen, click **Next**.
3. Follow the instructions on the screen.

If you have other software problems —

- Back up your files immediately.
 - Use a virus-scanning program to check the hard drive or CDs.
 - Save and close any open files or programs and shut down your computer through the **Start** menu.
 - Check the software documentation or contact the software manufacturer for troubleshooting information:
 - Ensure that the program is compatible with the operating system installed on your computer.
 - Ensure that your computer meets the minimum hardware requirements needed to run the software. See the software documentation for information.
 - Ensure that the program is installed and configured properly.
- Verify that the device drivers do not conflict with the program.
 - If necessary, uninstall and then reinstall the program, Dell Support Center.
 - Write down any error message that is displayed to help in troubleshooting when Contacting Dell.

Using Support Tools

 **NOTE:** The instructions in this section are for computers with Windows XP operating system installed.

Dell Support Center

The **Dell Support Center** helps you find the service, support, and system-specific information you need. For more information about **Dell Support Center** and available support tools, click the **Services** tab at support.dell.com.



Click the  icon in the taskbar to run the application. The home page provides links to access:

- Self Help (Troubleshooting, Security, System Performance, Network/Internet, Backup/Recovery, and Windows operating system)
- Alerts (technical support alerts relevant to your computer)

- Assistance from Dell (Technical Support with DellConnect™, Customer Service, Training and Tutorials, How-To Help with Dell on Call, and Online Scan with PCCheckUp)
- About Your System (System Documentation, Warranty Information, System Information, Upgrades & Accessories)

The top of the **Dell Support Center** home page displays your computer's model number along with its service tag and express service code.

For more information about the **Dell Support Center**, see the *Dell Technology Guide* on your hard drive or on the Dell Support website at support.dell.com.

System Messages

If your computer has an issue or error, it may display a System Message that will help you identify the cause and action needed to resolve the issue.

 **NOTE:** If the message you received is not listed in the following examples, see the documentation for either the operating system or the program that was running when the message appeared. Alternatively see the *Dell Technology Guide* on your hard disk or the Dell Support website at support.dell.com.

Alert! Previous attempts at booting this system have failed at checkpoint [nnnn]. For help in resolving this problem, please note this checkpoint and contact Dell Technical Support — The computer failed to complete the boot routine three consecutive times for the same error (see “Contacting Dell” on page 51 for assistance).

CMOS checksum error — Possible motherboard failure or RTC battery low. Replace the battery. (See the *Dell Technology Guide* on your hard disk or the Dell Support website at support.dell.com or see “Contacting Dell” on page 51 for assistance).

Hard-disk drive (HDD) failure — Possible hard disk drive failure during POST (see “Contacting Dell” on page 51 for assistance).

Hard-disk drive (HDD) read failure — Possible hard disk drive failure during HDD boot test (see “Contacting Dell” on page 51 for assistance).

Keyboard failure — Keyboard failure or loose cable.

No boot device available — No bootable partition on hard disk drive, the hard disk drive connector is loose, or no bootable device exists.

- If the hard drive is your boot device, ensure that the connector is connected and that the drive is installed properly and partitioned as a boot device.

Using Support Tools

- Enter system setup and ensure that the boot sequence information is correct (see the *Dell Technology Guide* on your hard disk or the Dell Support website at support.dell.com).

No timer tick interrupt — A chip on the system board might be malfunctioning or motherboard failure (see “Contacting Dell” on page 51 for assistance).

USB over current error — Disconnect the USB device. Your USB device needs more power for it to function properly. Use an external power source to connect the USB device, or if your device has two USB cables, connect both of them.

NOTICE - Hard Drive SELF MONITORING SYSTEM has reported that a parameter has exceeded its normal operating range. Dell recommends that you back up your data regularly. A parameter out of range may or may not indicate a potential hard drive problem — S.M.A.R.T error, possible hard disk drive failure.

This feature can be enabled or disabled in the BIOS setup (see “Contacting Dell” on page 51 for assistance).

Hardware Troubleshooter

If a device is either not detected during the operating system setup or is detected but incorrectly configured, you can use the **Hardware Troubleshooter** to resolve the incompatibility.

To start the Hardware Troubleshooter:

1. Click **Start** → **Help and Support**.
2. Type `hardware troubleshooter` in the search field and press <Enter> to start the search.
3. In the search results, select the option that best describes the problem and follow the remaining troubleshooting steps.

Dell Diagnostics

If you experience a problem with your computer, perform the checks in “Lockups and Software Problems” on page 32 and run the Dell Diagnostics before you contact Dell (see “Contacting Dell” on page 51) for technical assistance.

It is recommended that you print these procedures before you begin.

 **NOTE:** Dell Diagnostics works only on Dell computers.

 **NOTE:** The *Drivers and Utilities* disc is optional and may not ship with your computer.

To review your computer's configuration information, and ensure that the device that you want to test displays in the system setup program and is active. See the System Setup section in the *Dell Technology Guide*.

Start the Dell Diagnostics from your hard drive or from the *Drivers and Utilities* disc.

Starting Dell Diagnostics From Your Hard Drive

The Dell Diagnostics is located on a hidden diagnostic utility partition on your hard drive.

 **NOTE:** If your computer cannot display a screen image, see “Contacting Dell” on page 51.

1. Ensure that the computer is connected to an electrical outlet that is known to be working properly.
2. Turn on (or restart) your computer.
3. When the DELL™ logo appears, press <F12> immediately. Select **Diagnostics** from the boot menu and press <Enter>.

 **NOTE:** If you wait too long and the operating system logo appears, continue to wait until you see the Microsoft® Windows® desktop; then, shut down your computer and try again.

 **NOTE:** If you see a message stating that no diagnostics utility partition has been found, run the Dell Diagnostics from the *Drivers and Utilities* disc.

Using Support Tools

4. Press any key to start the Dell Diagnostics from the diagnostics utility partition on your hard drive.

Starting Dell Diagnostics From the Drivers and Utilities Disc

 **NOTE:** Your computer does not have an internal optical drive. Use an external optical drive or any external storage device for the procedures that involve discs.

1. Insert the *Drivers and Utilities* disc.
2. Shut down and restart the computer. When the DELL logo appears, press <F2> immediately.

 **NOTE:** If you wait too long and the operating system logo appears, continue to wait until you see the Microsoft® Windows® desktop; then, shut down your computer and try again.

 **NOTE:** The next steps change the boot sequence for one time only. On the next start-up, the computer boots according to the devices specified in the system setup program.

3. When the boot device list appears, highlight **CD/DVD/CD-RW** and press <Enter>.
4. Select the **Boot from CD-ROM** option from the menu that appears and press <Enter>.
5. Type 1 to start the CD menu and press <Enter> to proceed.
6. Select **Run the 32 Bit Dell Diagnostics** from the numbered list. If multiple versions are listed, select the version appropriate for your computer.
7. When the Dell Diagnostics **Main Menu** appears, select the test you want to run.

Restoring Your Operating System

You can restore your operating system in the following ways:

- System Restore returns your computer to an earlier operating state without affecting data files. Use System Restore as the first solution for restoring your operating system and preserving data files.
- Dell Factory Image Restore returns your hard drive to the operating state it was in when you purchased the computer. This procedure permanently deletes all data on the hard drive and removes any programs installed after you received the computer. Use Dell Factory Image Restore only if System Restore did not resolve your operating system problem.
- If you received an Operating System disc with your computer, you can use it to restore your operating system. However, using the

Operating System disc also deletes all data on the hard drive. Use the disc only if System Restore did not resolve your operating system problem.

System Restore

The Windows operating systems provide a System Restore option which allows you to return your computer to an earlier operating state (without affecting data files) if changes to the hardware, software, or other system settings have left the computer in an undesirable operating state. Any changes that System Restore makes to your computer are completely reversible.



CAUTION: Make regular backups of your data files. System Restore does not monitor your data files or recover them.

 **NOTE:** The procedures in this document were written for the Windows default view, so they may not apply if you set your Dell™ computer to the Windows Classic view.

Starting System Restore

1. Click **Start**→ **All Programs**→ **Accessories**→ **System Tools**→ **System Restore**.
2. In the welcome screen, click **Next**.
3. Follow the instructions on the screen.

Undoing the Last System Restore

 **NOTE:** Before you undo the last system restore, save and close all open files and exit any open programs. Do not alter, open, or delete any files or programs until the system restoration is complete.

1. Click **Start**→ **All Programs**→ **Accessories**→ **System Tools**→ **System Restore**.
2. In the welcome screen, click **Undo my last restoration** and then click **Next**.
3. Follow the instructions on the screen.

Using Dell™ PC Restore

 **CAUTION:** Using Dell PC Restore permanently deletes all data on the hard drive and removes any programs or drivers installed after you received your computer. If possible, back up the data before using these options. Use PC Restore only if System Restore did not resolve your operating system problem.

 **NOTE:** Dell PC Restore by Symantec and Dell Factory Image Restore may not be available in certain countries or on certain computers.

Use Dell PC Restore only as the last method to restore your operating system. These options restore your hard drive to the operating state it was in when you purchased the computer. Any programs or files added since you received your computer—including data files—are permanently deleted from the hard drive.

Data files include documents, spreadsheets, e-mail messages, digital photos, music files, and so on. If possible, back up all data before using PC Restore.

To perform PC Restore:

1. Turn on the computer.

During the boot process, a blue bar with **www.dell.com** appears at the top of the screen.

2. Immediately upon seeing the blue bar, press <Ctrl><F11>. If you wait too long and the operating system logo appears, continue to wait until you see the Microsoft® Windows® desktop; then, shut down your computer and try again.

 **CAUTION:** If you do not want to proceed with PC Restore, click **Reboot**.

3. Click **Restore** and click **Confirm**.

The restore process takes approximately 6 to 10 minutes to complete.

4. When prompted, click **Finish** to reboot the computer.

 **NOTE:** Do not manually shut down the computer. Click **Finish** and let the computer completely reboot.

5. When prompted, click **Yes**.

The computer restarts. Because the computer is restored to its original operating state, the screens that appear, such as the End User License Agreement, are the same ones that appeared the first time the computer was turned on.

6. Click **Next**.

The System Restore screen appears and the computer restarts.

After the computer restarts, click **OK**.

Operating System Reinstallation

Before You Begin

If you are considering reinstalling the Windows operating system to correct a problem with a newly installed driver, first try using Windows Device Driver Rollback. If Device Driver Rollback does not resolve the problem, then use System Restore to return your operating system to the operating state it was in before you installed the new device driver. See “System Restore” on page 40.

 **CAUTION:** Before performing the installation, back up all data files on your primary hard drive. For conventional hard drive configurations, the primary hard drive is the first drive detected by the computer.

To reinstall Windows, you need the following items:

- Dell *Operating System* disc
- Dell *Drivers and Utilities* disc

 **NOTE:** The Dell *Drivers and Utilities* disc contains drivers that were installed during the assembly of the computer. Use the Dell *Drivers and Utilities* disc to load any required drivers. Depending on the region from which you ordered your computer, or whether you requested the disc, the Dell *Drivers and Utilities* disc and *Operating System* disc may not ship with your computer.

Reinstalling Windows

The reinstallation process can take 1 to 2 hours to complete. After you reinstall the operating system, you must also reinstall the device drivers, virus protection program, and other software.

 **NOTE:** Your computer does not have an internal optical drive. Use an external optical drive or any external storage device for the procedures that involve discs.

1. Save and close any open files and exit any open programs.
2. Insert the *Operating System* disc.
3. Click **Exit** if the **Install Windows** message appears.
4. Restart the computer.

5. When the DELL logo appears, press <F2> immediately.

 **NOTE:** If you wait too long and the operating system logo appears, continue to wait until you see the Microsoft® Windows® desktop; then, shut down your computer and try again.

 **NOTE:** The next steps change the boot sequence for one time only. On the next start-up, the computer boots according to the devices specified in the system setup program.

6. When the boot device list appears, highlight **CD/DVD/CD-RW Drive** and press <Enter>.
7. Press any key to **Boot from CD-ROM**. Follow the instructions on the screen to complete the installation.

Getting Help

If you experience a problem with your computer, you can complete the following steps to diagnose and troubleshoot the problem:

1. See “Solving Problems” on page 28 for information and procedures that pertain to the problem your computer is experiencing.
2. See “Dell Diagnostics” on page 37 for procedures on how to run Dell Diagnostics.
3. Fill out the “Diagnostic Checklist” on page 50.
4. Use Dell’s extensive suite of online services available at Dell Support (support.dell.com) for help with installation and troubleshooting procedures. See “Online Services” on page 47 for a more extensive list of Dell Support online.
5. If the preceding steps have not resolved the problem, see “Before You Call” on page 50 and then “Contacting Dell” on page 51.

 **NOTE:** Call Dell Support from a telephone near or at the computer so that the support staff can assist you with any necessary procedures.

 **NOTE:** Dell’s Express Service Code system may not be available in all countries.

When prompted by Dell’s automated telephone system, enter your Express Service Code to route the call directly to the proper support personnel. If you do not have an Express Service Code, open the **Dell Accessories** folder, double-click the **Express Service Code** icon, and follow the directions.

 **NOTE:** Some of the services mentioned below are not always available in all locations outside the continental U.S. Call your local Dell representative for information on availability.

Technical Support and Customer Service

Dell's support service is available to answer your questions about Dell hardware. Our support staff use computer-based diagnostics to provide fast, accurate answers.

To contact Dell's support service, see "Before You Call" on page 50 and then see the contact information for your region or go to support.dell.com.

Online Services

You can learn about Dell products and services on the following websites:

- www.dell.com
- www.dell.com/ap (Asian/Pacific countries only)
- www.dell.com/jp (Japan only)
- www.euro.dell.com (Europe only)
- www.dell.com/la (Latin American and Caribbean countries)
- www.dell.ca (Canada only)

You can access Dell Support through the following websites and e-mail addresses:

Dell Support websites

- support.dell.com
- support.jp.dell.com (Japan only)
- support.euro.dell.com (Europe only)

Dell Support e-mail addresses

- mobile_support@us.dell.com
- support@us.dell.com
- la-techsupport@dell.com (Latin America and Caribbean countries only)
- apsupport@dell.com (Asian/Pacific countries only)

Dell Marketing and Sales e-mail addresses

- apmarketing@dell.com (Asian/Pacific countries only)
- sales_canada@dell.com (Canada only)

Getting Help

Anonymous file transfer protocol (FTP)

- **ftp.dell.com**

Log in as user: `anonymous`, and use your e-mail address as your password.

Automated Order-Status Service

To check on the status of any Dell products that you have ordered, you can go to

support.dell.com, or you can call the automated order-status service. A recording prompts you for the information needed to locate and report on your order. For the telephone number to call your region, see “Contacting Dell” on page 51 for problems with your order.

If you have a problem with your order, such as missing parts, wrong parts, or incorrect billing, contact Dell for customer assistance. Have your invoice or packing slip handy when you call. For the telephone number to call for your region, see “Contacting Dell” on page 51.

Product Information

If you need information about additional products available from Dell, or if you would like to place an order, visit the Dell website at **www.dell.com**. For the telephone number to call for your region or to speak to a sales specialist, see “Contacting Dell” on page 51.

Returning Items for Repair Under Warranty or for Credit

Prepare all items being returned, whether for repair or credit, as follows:

1. Call Dell to obtain the procedures on returning the items for repair under warranty or for credit.

 **NOTE:** For the telephone number to call for your region, see “Contacting Dell” on page 51.

2. Include a copy of the invoice and a letter describing the reason for the return.
3. Include a copy of the Diagnostics Checklist (see “Dell Diagnostics” on page 37), indicating the tests that you have run and any error messages reported by the Dell Diagnostics (see “Dell Diagnostics” on page 37).

4. Include any accessories that belong with the item(s) being returned (power cables, software, guides, and so on) if the return is for credit.

5. Pack the equipment to be returned in the original (or equivalent) packing materials.

 **NOTE:** You are responsible for paying shipping expenses. You are also responsible for insuring any product returned, and you assume the risk of loss during shipment to Dell. Collect On Delivery (C.O.D.) packages are not accepted.

 **NOTE:** Returns that are missing any of the preceding requirements will be refused at Dell’s receiving dock and returned to you.

Before You Call

 **NOTE:** Have your Express Service Code ready when you call. The code helps Dell's automated-support telephone system direct your call more efficiently. You may also be asked for your Service Tag (located on the back or bottom of your computer).

Remember to fill out the following Diagnostics Checklist. If possible, turn on your computer before you call Dell for assistance and call from a telephone at or near the computer. You may be asked to type some commands at the keyboard, relay detailed information during operations, or try other troubleshooting steps possible only at the computer itself. Ensure that the computer documentation is available.

Diagnostic Checklist

- Name:
- Date:
- Address:
- Phone number:
- Service Tag (bar code on the back or bottom of the computer):
- Express Service Code:
- Return Material Authorization Number (if provided by Dell support technician):
- Operating system and version:
- Devices:
- Expansion cards:
- Are you connected to a network? Yes/No
- Network, version, and network adapter:
- Programs and versions:

See your operating system documentation to determine the contents of the computer's start-up files. If the computer is connected to a printer, print each file. Otherwise, record the contents of each file before calling Dell.

- Error message, beep code, or diagnostic code:
- Description of problem and troubleshooting procedures you performed:

Contacting Dell

For customers in the United States, call 800-WWW-DELL (800-999-3355).

 **NOTE:** If you do not have an active Internet connection, you can find contact information on your purchase invoice, packing slip, bill, or Dell product catalog.

Dell provides several online and telephone-based support and service options. Availability varies by country and product, and some services may not be available in your area.

To contact Dell for sales, technical support, or customer service issues:

1. Visit **support.dell.com**.
2. Verify your country or region in the **Choose A Country/Region** drop-down menu at the bottom of the page.
3. Click **Contact Us** on the left side of the page.
4. Select the appropriate service or support link based on your need.
5. Choose the method of contacting Dell that is convenient for you.

Finding More Information and Resources

If you need to:**See:**

reinstall your operating system.

the Operating System disc.

run a diagnostic program for your computer, reinstall desktop system software, or update drivers for your computer, and readme files.

the *Drivers and Utilities* disc.



NOTE: Drivers and documentation updates can be found on the Dell™ Support website at **support.dell.com**.

learn more about your operating system, maintaining peripherals, RAID, Internet, Bluetooth®, networking, and e-mail.

the *Dell Technology Guide* installed on your hard drive.

upgrade your computer with new or additional memory, or a new hard drive.

the *Service Manual* on the Dell Support website at **support.dell.com**



NOTE: In some countries, opening and replacing parts of your computer may void your warranty. Check your warranty and return policies before working inside your computer.

If you need to:

find safety best practices information for your computer.

review Warranty information, Terms and Conditions (U.S. only), Safety instructions, Regulatory information, Ergonomics information, and End User License Agreement.

find your Service tag/Express Service Code — You must use the service tag to identify your computer on **support.dell.com** or to contact technical support.

find drivers and downloads.

access technical support and product help.

check on your order status for new purchases.

find solutions and answers to common questions.

locate information for last-minute updates about technical changes to your computer or advanced technical-reference material for technicians or experienced users.

See:

the safety and regulatory documents that shipped with your computer and also see the Regulatory Compliance Homepage at **www.dell.com/regulatory_compliance**.

the back or bottom of your computer.

the Dell™ Support website at **support.dell.com**.

Specifications

System model

Inspiron 1011

This section provides information that you may need when setting up, updating drivers for, and upgrading your computer.

 **NOTE:** Offerings may vary by region. For more information regarding the configuration of your computer, click **Start**→ **Help and Support** and select the option to view information about your computer.

Processor

Type	Intel® Atom™ N270 Intel Atom N280
L2 cache	512 KB
External bus frequency	533 MHz and 667 MHz

Memory

Connectors	one internally-accessible SO-DIMM socket
Capacities	512 MB and 1 GB
Memory type	DDR2-800 (Run @ DDR2-533 MHz)
Memory configurations possible	512 MB, 1 GB

Computer information

System chipset	Intel 945GSE UMA
Data bus width	64 bits
DRAM bus width	single channel 64-bit buses
Processor address bus width	32 bits
Flash EEPROM	1 MB
PCI Bus	32 bits

Internal storage

Type	Capacity
2.5" HDD SATA	120 GB or 160 GB @ 5400 rpm
2.5" SSD (Solid-state drive) MLC	8 GB or 16 GB

Communications

Modem (optional)	External V.92 56K USB Modem
Modem interface	Universal Serial Bus (USB)
Network adapter	10/100 Ethernet LAN on system board
Wireless	internal WLAN (half-size Mini-Card) with WiFi bgn, Bluetooth® wireless technology

Video

Video controller	Intel 945GSE UMA
Video memory	8 MB system memory (shared)
LCD interface	LVDS

Specifications

Audio

Audio type	2 channel High Definition Audio
Audio controller	Realtek ALC272
Stereo conversion	24-bit (analog-to-digital and digital-to-analog)
Internal interface	Intel High Definition Audio
External interface	microphone-in connector, stereo headphones/ speakers connector, digital MIC with camera module
Speaker	two 1.0 watt speakers

Audio

Internal speaker amplifier	1.0 watt per channel
Volume controls	software program controlled

Ports and connectors

Audio	one microphone connector, one stereo headphone/ speaker connector, digital MIC with camera module
Mini-Card	one full size Mini-Card slot and one half size Mini-Card slot, the half size slot supports dual interface and the full size slot supports USB only
Network adapter	RJ45 port

Ports and connectors

USB	two 4-pin USB 2.0-compliant connectors one 4-pin power USB 2.0-compliant connector
Video	15-hole connector

Display

Type (TrueLife)	10.1 inch WSVGA
<i>Dimensions:</i>	
Height	222.72 mm (8.76 inches)
Width	125.28 mm (4.93 inches)
Diagonal	255.52 mm (10.06 inches)
Maximum resolution	1024 x 576
Refresh rate	60 Hz
Operating angle	0° (closed) to 135°

Display

Luminance	162 min. 180 typ. cd/m ² (5 point avg)
<i>Viewing Angles:</i>	
Horizontal	±40° (CR ≥ 10) typ. WSVGA AG
Vertical	+10° – +30° (CR ≥ 10) typ. WSVGA
Pixel pitch	0.2175 x 0.2175 mm
Controls	brightness can be controlled through keyboard shortcuts (see <i>Dell Technology Guide</i> for more information)

Specifications

Camera		Battery	
Pixel	1.3 megapixel	Type	3-cell/6-cell lithium ion
Video resolution	320 x 240 ~1280 x 1024 (640 x 480 at 30 fps)	Depth	23.1 mm (0.91 inches) (3-cell)
Diagonal viewing angle	66°		45.62 mm (1.80 inches) (6-cell)
Touch pad		Height	39.04 mm (1.54 inches) (3-cell)
X/Y position resolution (graphics table mode)	240 cpi		45.7 mm (1.80 inches) (6-cell)
<i>Size:</i>		Width	204.14 mm (8.04 inches) (3-cell)
Width	78.5 mm (3.09 inches) sensor-active area		214.0 mm (8.42 inches) (6-cell)
Height	38 mm (1.49 inches) rectangle	Weight	0.165 kg (0.36 lb) (3-cell)
			0.350 kg (0.77 lb) (6-cell)

Battery

Voltage	11.1 VDC (3/6-cell)
<i>Charge time (approximate):</i>	
Computer off	3.0 hours (3-cell) 4.0 hours (6-cell)
Operating	0° to 35°C (32° to 95°F)
Storage	-40° to 65°C (-40° to 149°F)
Coin-cell battery	CR-2032

AC adapter

Input voltage	100–240 VAC
Input current (maximum)	0.8A
Input frequency	50–60 Hz
Output power	30 W

AC adapter

Output current	1.58 A (continuous)
Rated output voltage	19.0 VDC
<i>Dimensions:</i>	
30 W APD	
Height	63.2 mm (2.50 inches)
Width	34.0 mm (1.34 inches)
Depth	85.0 mm (3.35 inches)
Weight (with cables)	0.19 kg (0.42 lb)
30 W PI	
Height	62.0 mm (2.44 inches)
Width	38.9 mm (1.53 inches)
Depth	78.0 mm (3.07 inches)
Weight (with cables)	0.185 kg (0.41 lb)

Specifications

AC adapter

30 W Delta

Height 59.2 mm (2.33 inches)

Width 34.0 mm (1.34 inches)

Depth 85.0 mm (3.35 inches)

Weight (with cables) 0.205 kg (0.45 lb)

Physical

Height 26.8 mm to 28.3 mm
(1.06 to 1.11 inches)

Width 261 mm (10.27 inches)

Depth 182 mm (7.16 inches)

Weight (with 3-cell
battery): Configurable to
less than
1.35 kg (2.98 lb)

Computer environment

Temperature range:

Operating 0° to 35°C
(32° to 95°F)

Storage -20° to 65°C
(-4° to 149°F)

Relative humidity (maximum):

Operating 10% to 90%
(noncondensing)

Storage 5% to 90%
(noncondensing)

Maximum vibration (using a random-vibration spectrum that simulates user environment):

Operating 0.66 GRMS

Storage 1.3 GRMS

Computer environment

Maximum shock (measured with hard drive in head-parked position and a 2-ms half-sine pulse):

Operating	110 G
Storage	160 G

Index

A

AC adapter

size and weight **57, 58**

airflow, allowing **5**

B

backups

creating **25**

C

calling Dell **48**

chipset **53**

computer, setting up **5**

connect(ing)

to the Internet **10**

Contacting Dell online **49**

customer service **45**

62

D

damage, avoiding **5**

Dell Factory Image Restore **38**

Dell Support Center **32**

Dell support website **51**

Dell Technology Guide

for further information **50**

Diagnostic Checklist **48**

drivers and downloads **51**

E

e-mail addresses

for technical support **45**

expansion bus **53**

F

finding more information **50**

FTP login, anonymous **46**

H

hardware problems

 diagnosing **34**

Hardware Troubleshooter **34**

help

 getting assistance and support **44**

I

Internet connection **10**

ISP

 Internet Service Provider **10**

M

memory problems

 solving **29**

memory support **52**

Microsoft® Windows® XP

 setup **9**

N

network connection

 fixing **27**

network speed

 testing **26**

O

order status **46**

P

power problems, solving **28**

power strips, using **6**

problems, solving **26**

Index

processor **52**

products

information and purchasing **46**

R

reinstalling Windows **38**

resources, finding more **50**

S

setup, before you begin **5**

software features **24**

software problems **30**

solving problems **26**

specifications **52**

support e-mail addresses **45**

support sites

worldwide **45**

System Messages **33**

system reinstall options **38**

System Restore **38**

T

technical support **45**

V

ventilation, ensuring **5**

W

warranty returns **47**

Windows, reinstalling **38**

wired network

network cable, connecting **7**

wireless network connection **26**

Printed in China.
Printed on recycled paper.

www.dell.com | support.dell.com



OK621PA00